



RGBW & Tunable White LED Controller

STCV-B-100W-C-RGBW

Overview

Our advanced RGBW Controller converts RGBW tape lights, including 3000K white, into dynamically tunable white lighting with high CRI (83-90) by precisely mixing RGB. This innovative controller offers unparalleled flexibility and seamlessly integrates with existing system connectors, drivers, and accessories, ensuring optimal performance and enhanced user experience. Ideal for various applications, it delivers efficient, adjustable lighting solutions.

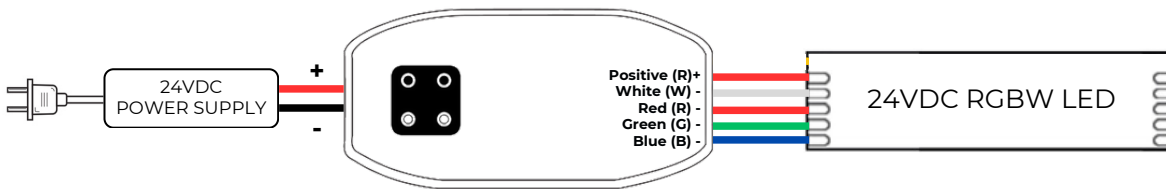
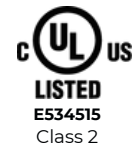

Features & Benefit

- Get tunable white control with RGBW tape and reduce SKU levels.
- Compatible with the Cyan wall switch, allowing you to control multiple CyanControllers.
- Boost lighting output by an extra 50% with a standard RGBW Tape light.
- Maximizing efficiency and brightness.
- Maintain control over your lights, even if your Wi-Fi goes down using the wall switch.
- Seamlessly integrate with the Smart Life app to control color dimming and advanced features like timers, save scenes, and more.
- Voice control via Amazon Alexa or Google Home.

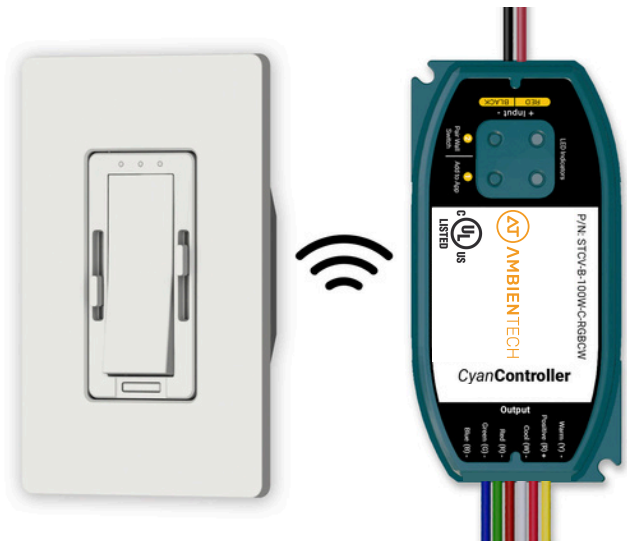

Voice Control



App Control



System Setup

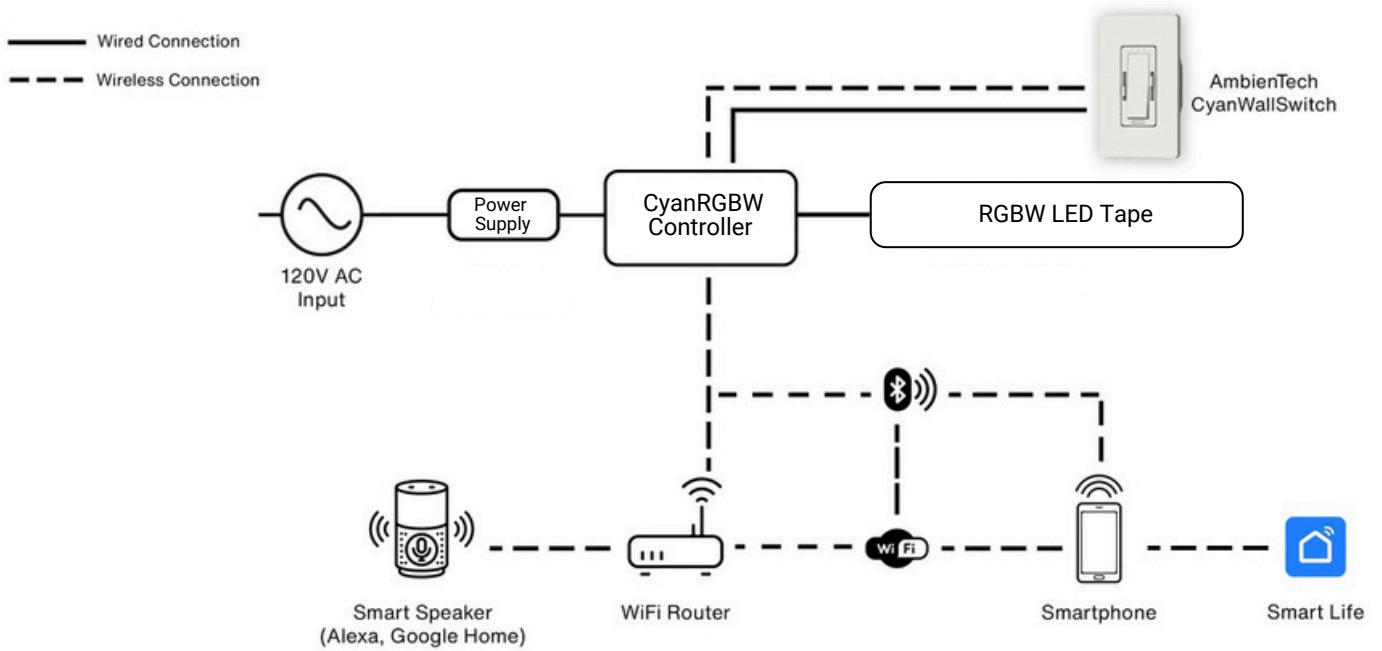

User Interface

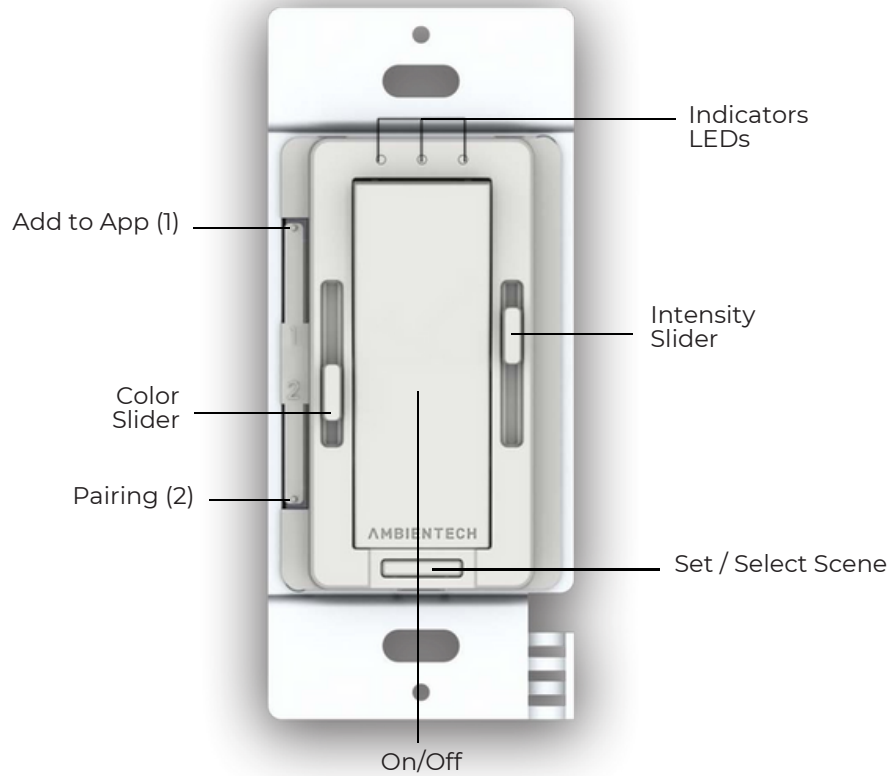

Electrical Performance

Specifications	Description
MaxPower:	100W/4A
Rated Voltage:	24VDC
Channels:	4 (RGBW)
Protection:	Over load, short circuit
Ambient Operating Temp:	-30 °C - + 40 °C / -86°F - + 104°F
IP Rating:	23 (Dry and damp locations)
Control Method:	Smart Life / CyanWallSwitch
Dimming Range:	0.1 - 100%
Color Control:	RGB + Tunable White
Dimming Method:	PWM (2400Hz)
Max Units:	32 with the CyanWallSwitch

RGBW vs Color Temperature with 3000K White

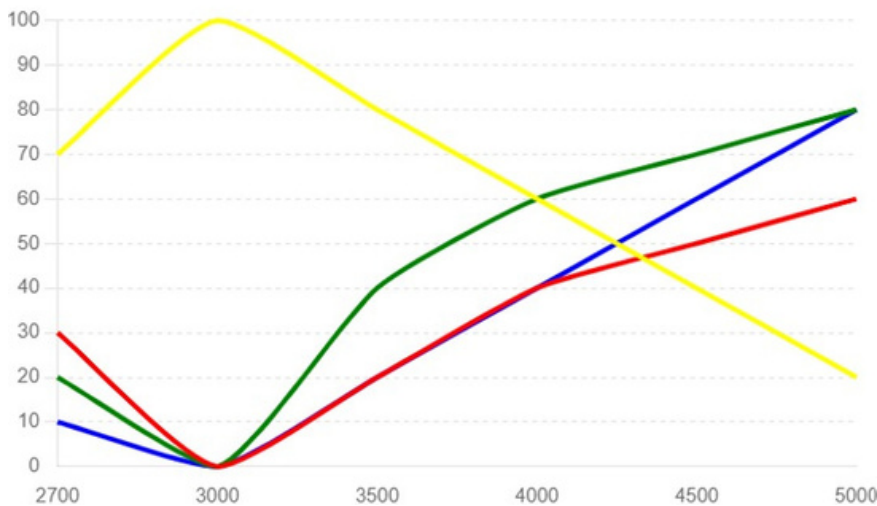

Mechanical Specification

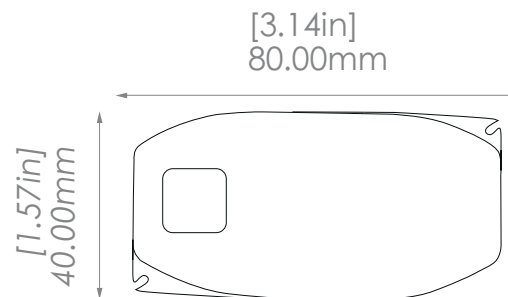
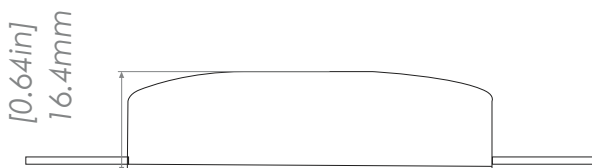

Tel: 347-652-2271

Website: www.ambientechinc.com

63 Flushing Avenue, Brooklyn, NY 11205