

Wall Switch Installation

Wall Box

1. A standard single-gang wall box sized 3 x 2 x 2 1/2 cm will service Dimmer
2. Not compatible with multi or double Mud Rings.
3. When using a retrofit gang box (cut in box) you might need to recess the ears.

Maximum Load

Input Voltage	Max Load
120VAC	700W

Note : A maximum of 7 Drivers can be controlled with each Wall Switch

Before You Begin

To avoid fire, shock, or death, turn the power Off at circuit breaker and test to ensure the power is Off before wiring.



Step 1: Prepare Wall Box Wires

1. Make sure that the ends of the wires from the wall box are straight (cut if needed).
2. Strip the wire insulator for each wire inside the wall box as shown here:

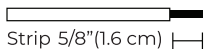

Step 2: Wire Wall Switch

Connect wires according to the wiring diagram below.

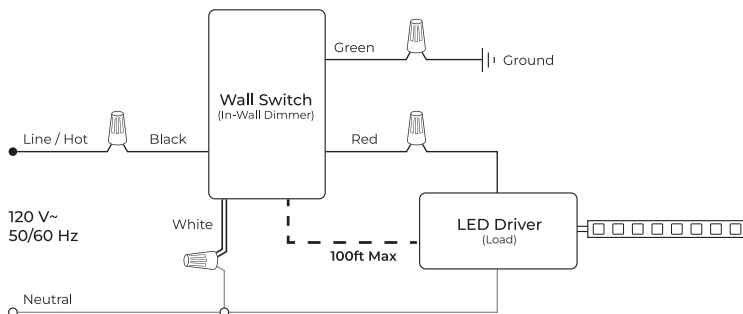

Wiring Description (Using wire connectors)

1. Connect the green (or bare copper) wire from the wall box to the green Wall Switch wire.
2. Connect the line/hot wire from the wall box to the black Wall Switch wire.
3. Connect the black LED Driver wire to the red Wall Switch wire.
4. Connect the white wire from the wall box to the white LED Driver wire and the white Wall Switch wire.

Step 3: Mount the Wall Switch

Mount the Wall Switch into the wall box using the screws provided.

Step 4: Restore Power

1. Turn the power On at the circuit breaker.
2. Verify 120V with a Voltmeter

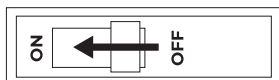

Item Identification

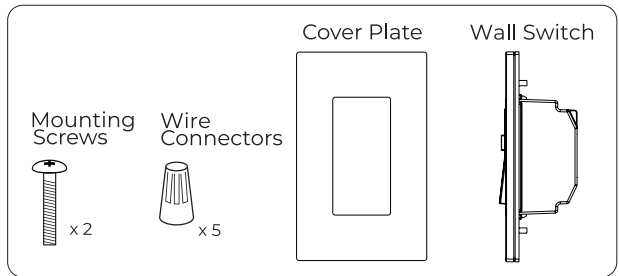

Pairing

If you are installing more than one Wall Switch unit, all others must be switched Off while pairing.

1. Make sure both sliders are set to the top and the Wall Switch is switched Off.
2. Switch the power On at the circuit breaker.
3. Turn On the Wall Switch, the green LED Indicator will blink while pairing.
5. After up to 15 seconds, your LED fixture will be paired with the Wall Switch.
6. To verify pairing is successful, move the sliders and ensure that the LEDs respond accordingly.
7. If you're installing a smart wall switch Scan the QR code to download the app. Follow the instructions to connect to the SmartAir App.

* If pairing is not successful press the Wall Switch pairing / reset button.

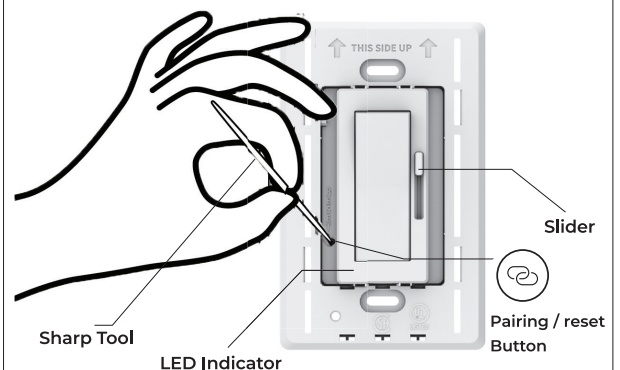

Connect to the SmartAir App

- Scan the QR code to download the App. Follow the instructions to connect to the SmartAir App



Operation - Dimmer Wall Switch

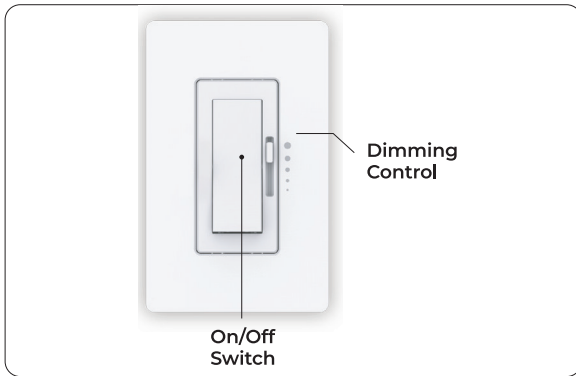

Customer Assistance

For technical questions regarding the installation or operation of this product, please contact our customer support team:

 347-334-6368 ext 3

 www.ambientechinc.com



Caution

To reduce the risk of overheating and possible damage to other equipment, do not install to control a receptacle, A motor-operated appliance, or a transformer-supplied appliance.

"GRADATEURS COMMANDANT UN BALLAST - AFIN DE REDUIRE LE RISQUE DE SURCHAUFFE ET LA POSSIBILITE D'ENDOMMAGEMENT A D'AUTRES MATERIELS, NE PAS INSTALLER POUR COMMANDER UNE PRISE, UN APPAREIL A MOTEUR,"

FCC/IC Information

This device complies with Part 15 of the FCC Rules. Operation is subject to the following two conditions:

1. This device may not cause harmful interference.
2. This device must accept any interference received, including interference that may cause undesired operation.

Troubleshooting

Symptoms	Cause	Possible Solution
Wall Switch LED Indicator blinking RED	The pairing / reset button is pressed while the wall switch is off	Turn ON the Wall Switch and press the Pairing button again
Wall Switch LED Indicator steady RED	The Wall Switch is trying to perform pairing	Turn On the Wall Switch until pairing is completed
Lights do not respond to Wall Switch	The Breaker is Off or tripped	Turn power On at the Circuit breaker
	Improper pairing	Perform "Pairing"
	Improper wiring	Make sure all wires are connected according to the wiring diagram
	Short circuit at the LED Driver output	Check LED Driver output for short circuits
The wall switch is controlling the wrong lights (Only if multiple Wall Switches units are installed in the same location)	The Wall Switch was paired with the wrong LED Driver	Perform "Pairing". Make sure all the other Wall Switches are turned Off while pairing
Wall Switch / LED Driver Replacement	Any reason	Perform "Pairing". Make sure all the other Wall Switches are turned Off while pairing